



# YETDA INDUSTRY LTD.

## 5W HIGH POWER LED (EMITTER V) G081E-5W

Features	Applications
* Long operating life	* Reading lights (car, bus, aircraft)
* Highest flux	* LCD Backlights/light Guides
* Available in White:2500K-25000K	* Fiber optic alternative/ Decorative Entertainment
* Lambertian radiation pattern	* Mini-accent/Up lighters/Down lighters/ Orientation
* More energy efficient than incandescent and most halogen lamps	* Indoor/Outdoor commercial and Residential Architectural
* Low voltage DC operated	* Cove/Under shelf/Task
* Cool beam, safe to the touch	* Bollards/Security/Garden
* Instant light (less than 100ns )	* Portable (flashlight, bicycle)
* Fully dimmable	* Edge-lit signs (Exit, point of sale)
* No UV	* Automotive Exit (Stop-Tail-Turn,CHMSL, Mirror Side Repeat)
* Superior ESD protection	* Traffic signaling / Beacons / RailCrossing and Wayside
* Eutectic die bonding	
* RoHS compliant	

### PACKAGE

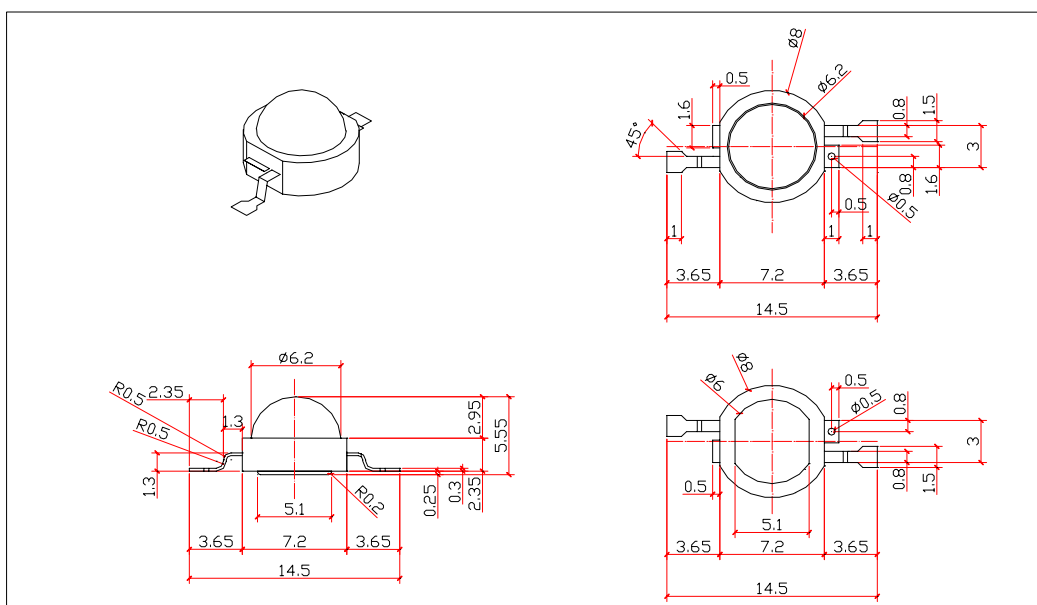



# YETDA INDUSTRY LTD.

## Typical Optical/ Electrical Characteristics @T<sub>J</sub>=25

Item	Symbol	Condition	Min.	Typ.	Max.	Unit
Forward Voltage	V <sub>F</sub>	I <sub>F</sub> =700mA	6		8	V
Reverse Current	I <sub>R</sub>	V <sub>R</sub> =5v			50	uA
50% Power Angle	2θ <sub>1/2</sub>	I <sub>F</sub> =700mA		120		deg
Luminous Intensity	φ <sub>V</sub>	I <sub>F</sub> =700mA		150	200	lm
Recommend Forward Current	I <sub>F</sub>	--		700		mA
Wavelength	d	I <sub>F</sub> =700mA		525		nm
Thermal Resistance, Junction to Case	R <sub>JP</sub>	I <sub>F</sub> =700mA		10		/w

### Notes:

1. Tolerance of measurement of forward voltage±0.1V.
2. Tolerance of measurement of peak Wavelength±2.0nm.
3. Tolerance of measurement of luminous intensity±15%.

### Absolute Maximum Rating

Item	Symbol	Absolute Maximum Rating	Unit
Forward Current	I <sub>F</sub>	700	mA
Peak Forward Current*	I <sub>FP</sub>	1200	mA
Reverse Voltage	V <sub>R</sub>	5	V
Power Dissipation	P <sub>D</sub>	5000	mW
Electrostatic discharge	E <sub>SD</sub>	±4500	V
Operation Temperature	T <sub>OPR</sub>	-40~+80	
Storage Temperature	T <sub>STG</sub>	-40~+100	
Lead Soldering Temperature*	T <sub>SOL</sub>	Max. 260 for 3sec Max.	

\*IFP Conditions : Pulse Width≤10msec duty≤1/10

\* All high power emitter LED products mounted on aluminum metal-core printed circuit board, can be lighted directly, but we do not recommend lighting the high power products for more than 5 seconds without a appropriate heat dissipation equipment.

\* Re-flow, wave peak and soak- stannum soldering etc.is not suitable for this products.

\* Suggest to solder it by professional high power LED soldering machine.

\* Can use invariable-temperature searing-iron with soldering condition:≤260 degree less than 3 seconds.

### Typical Optical/Electrical Characteristics Curves



# YETDA INDUSTRY LTD.

(T<sub>J</sub>=25 Unless Otherwise Noted )

Fig 1. Relative Luminous FLux vs. Forward Current

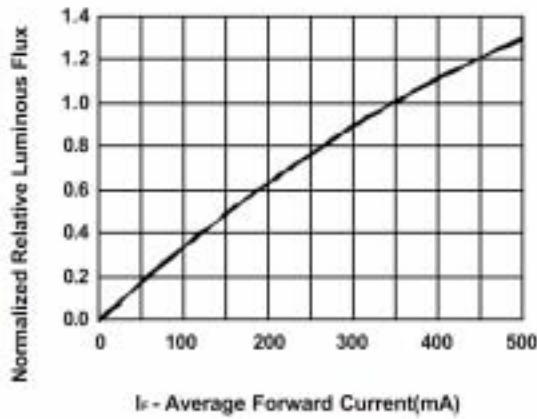

Fig 2. Forward Current vs. Forward Voltage

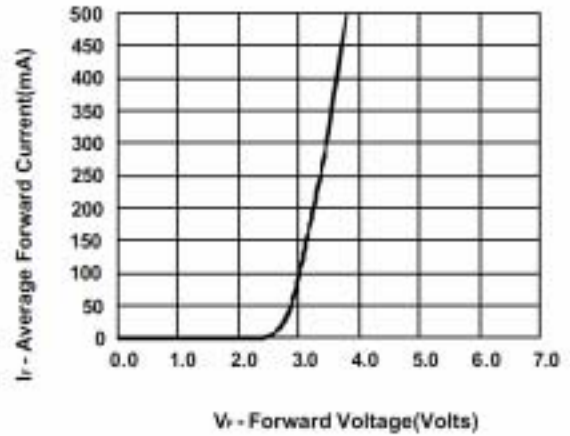

Fig 3. Maximum Forward Current vs. Ambient Temperature. Derating based on T<sub>max</sub>=120°C

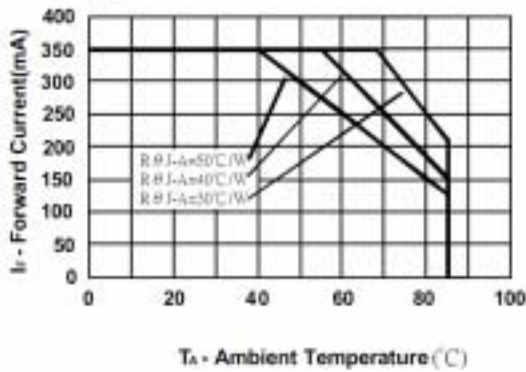

Fig 4. Relative Light Output vs. Junction Temperature

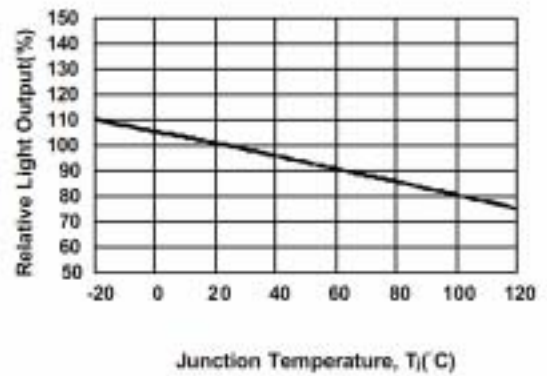

Fig 5. Relative Spectral Power Distribution vs. Wavelength

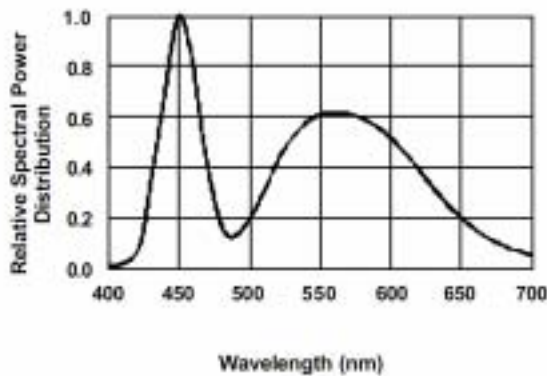
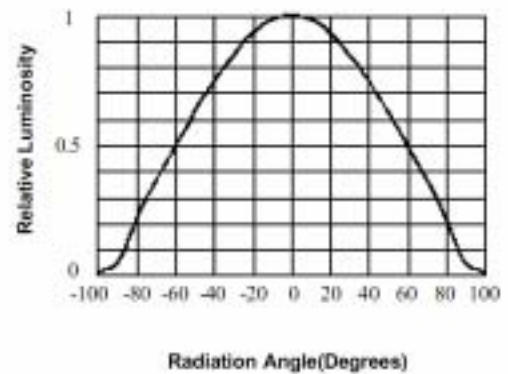
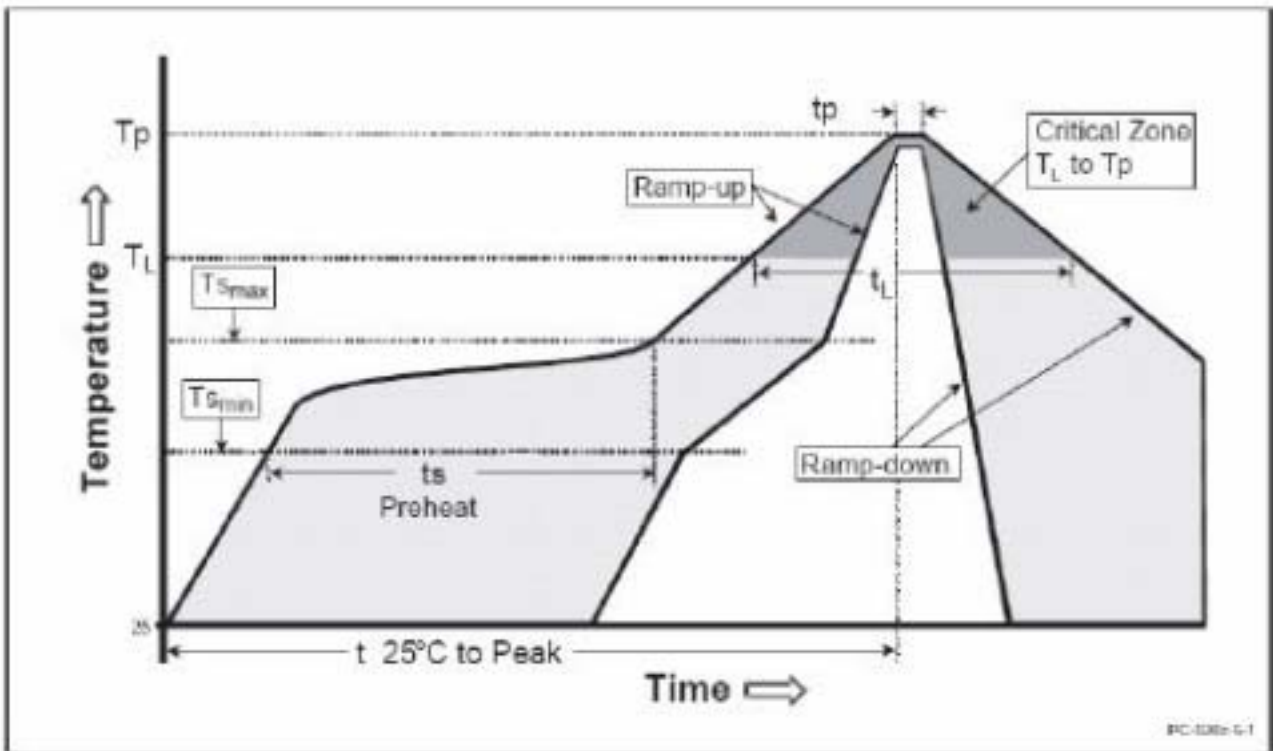

Fig 6. Relative Luminosity vs. Radiation Angle





# YETDA INDUSTRY LTD.



Profile Feature	Pb-Free Assembly
Preheat	
– Temperature Min (T <sub>Smin</sub> )	60-180 seconds
– Temperature Max (T <sub>Smax</sub> )	150 °C
– Time (t <sub>Smin</sub> to t <sub>Smax</sub> )	200 °C
– Temperature (T <sub>L</sub> )	
– Time (t <sub>L</sub> )	60-150 seconds
Time maintained above:	217 °C
Peak/Classification Temperature (T <sub>p</sub> )	260 °C
Time within 5 °C of actual Peak Temperature (t <sub>p</sub> )	20-40 seconds
Ramp-Down Rate	6 °C/second max.
Time 25 °C to Peak Temperature	8 minutes max.

## Notes

1. All temperatures refer to Solder Pad