

High Power Emitter LED

P/N: EBN11EAC (Bull)



ATTENTION
OBSERVE PRECAUTIONS
FOR HANDLING
ELECTROSTATIC
DISCHARGE
SENSITIVE
DEVICES



Features

- Long operating life
- Highest flux
- Available in Red
- Lambertian radiation pattern
- More energy efficient than incandescent and most halogen lamps
- Low voltage DC operated
- Cool beam, safe to the touch
- Instant light (less than 100ns)
- Fully dimmable
- No UV
- Superior ESD protection
- Eutectic die bonding
- RoHS compliant

Applications

- Reading lights (car, bus, aircraft)
- LCD Backlights/light Guides
- Fiber optic alternative/ Decorative / Entertainment
- Mini-accent/Up lighters/Down lighters/ Orientation
- Indoor/Outdoor commercial and Residential Architectural
- Cove/Under shelf/Task
- Bollards/Security/Garden
- Portable (flashlight, bicycle)
- Edge-lit signs (Exit, point of sale)
- Automotive Exit (Stop-Tail-Turn,CHMSL, Mirror Side Repeat)
- Traffic signaling / Beacons / RailCrossing and Wayside

Radiation Pattern

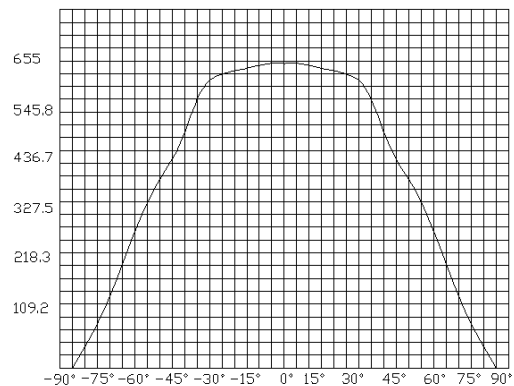
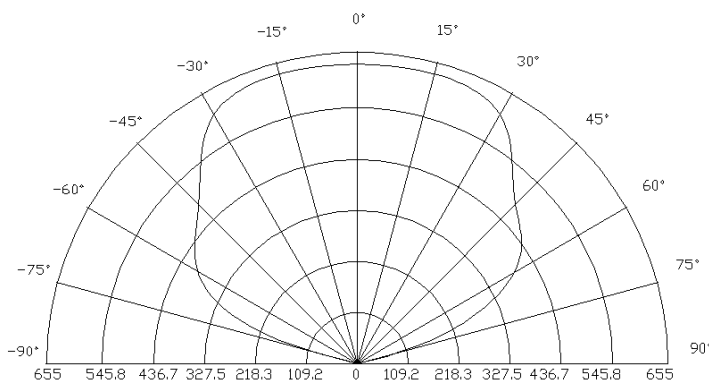

High Power Emitter LED

P/N: EBN11EAC (Bull)

Typical Optical/ Electrical Characteristics @T_J=25°C

Item	Symbol	Condition	Min.	Typ.	Max.	Unit
Forward Voltage	V _F	IF=350mA	3.0	--	3.8	V
Reverse Current	I _R	VR=5v	--	--	50	uA
50% Power Angle	2θ _{1/2}	IF=350mA	110	--	140	deg
Luminous Intensity	φ _v	IF=350mA	10.7		--	lm
Recommend Forward Current	I _F	--	--	350	--	mA
Wave Length	λ _d	IF=350mA	460	--	470	nm
Thermal Resistance,Junction to Case	R _{JP}	IF=350mA	--	10	--	°C/w

The sample delivers goods data

Item	Symbol	Condition	Min.	Avg.	Max.	Unit
Luminous Intensity	φ _v	IF=350mA				lm
50% Power Angle	2θ _{1/2}					deg
Forward Voltage	V _F					v
Wave Length	λ _d					nm

Notes:

- 1.Tolerance of measurement of forward voltage±0.1V.
- 2.Tolerance of measurement of peak Wavelength±2.0nm.
- 3.Tolerance of measurement of luminous intensity±15%.

Absolute Maximum Rating

Item	Symbol	Absolute Maximum Rating	Unit
Forward Current	I _F	350	mA
Peak Forward Current*	I _{FP}	500	mA
Reverse Voltage	V _R	5	V
Power Dissipation	P _D	1000	mW
Electrostatic discharge	E _{SD}	±2000	V
Operation Temperature	T _{OPR}	-40~+80	°C
Storage Temperature	T _{STG}	-40~+100	°C
Lead Soldering Temperature*	T _{SOL}	Max. 260°C for 3sec Max.	

*IFP Conditions: Pulse Width≤10msec duty≤1/10

* All high power emitter LED products mounted on aluminum metal-core printed circuit board, can be lighted directly, but we do not recommend lighting the high power products for more than 5 seconds without a appropriate heat dissipation equipment.

* Re-flow,wave peak and soak-stannum soldering etc.is not suitable for this products.

* Suggest to solder it by professional high power LED soldering machine.

* Can use invariable-temperature searing-iron with soldering condition:≤260 degree less than 3 seconds.

High Power Emitter LED

P/N: EBN11EAC (Bull)

Typical Optical/Electrical Characteristics Curves ($T_J=25^\circ\text{C}$ Unless Otherwise Noted)

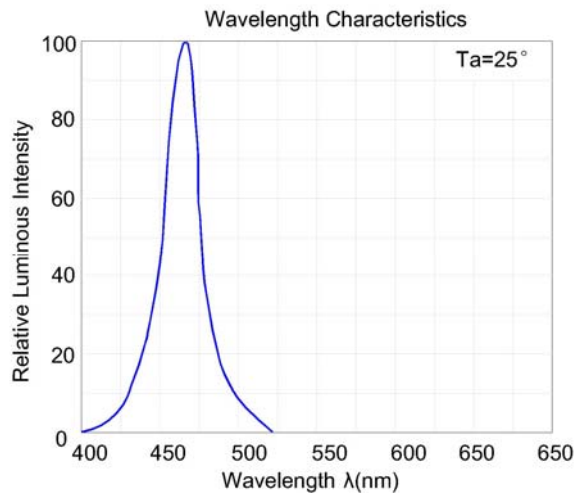
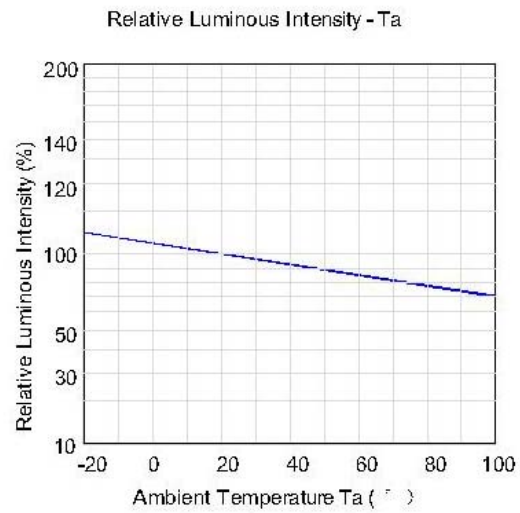
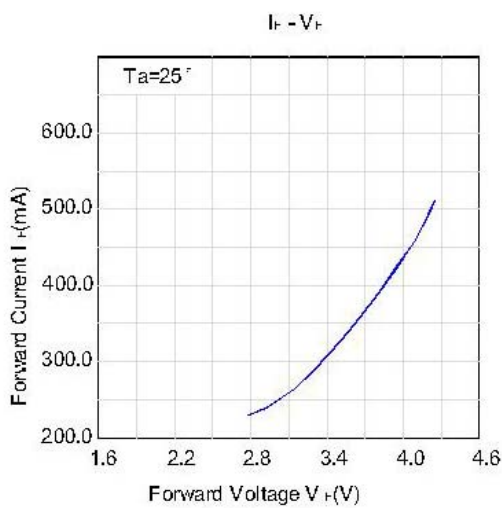
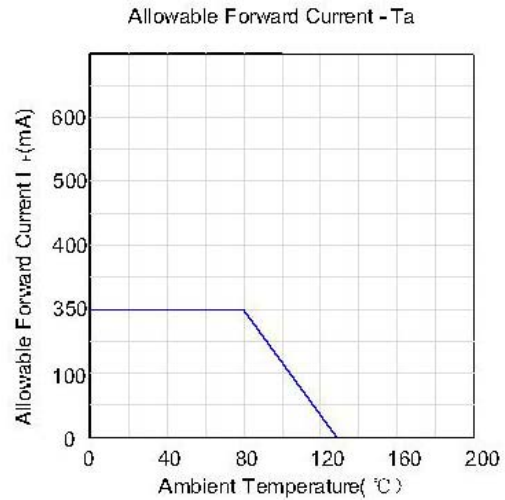
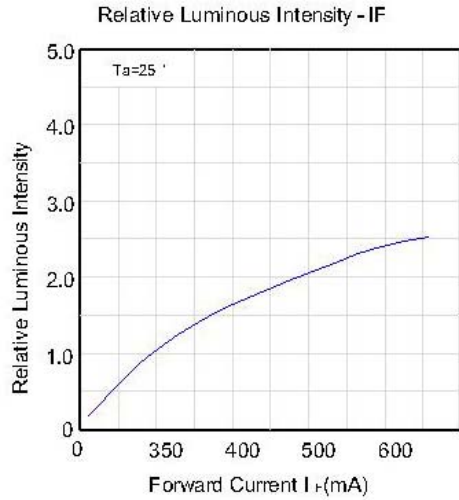

High Power Emitter LED
P/N: EBN11EAC (Bull)

Package Dimensions

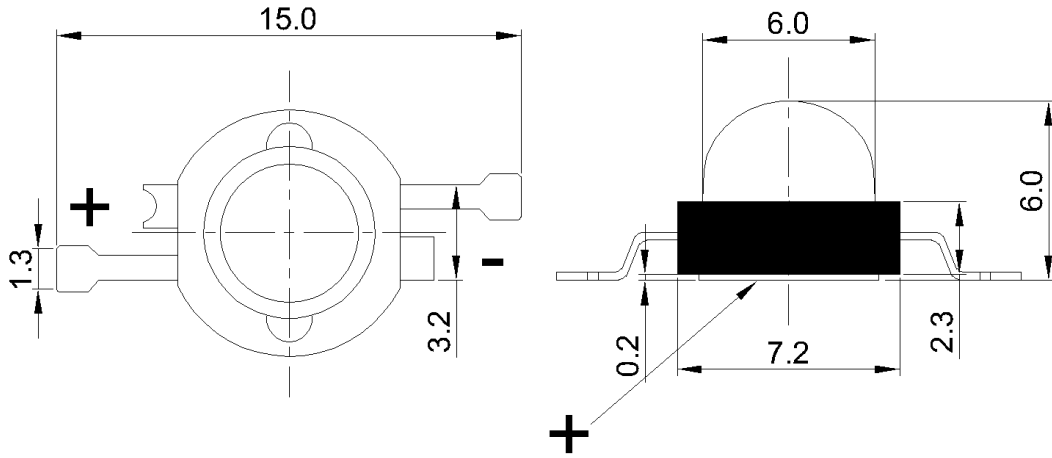

Notes:

1. All dimension units are millimeters.
2. All dimension tolerance is $\pm 0.2\text{mm}$ unless otherwise noted.

Tape Specifications(Units:mm)

