

High Power Emitter LED

P/N: EWJ85EAC-LVR8 (White)



ATTENTION
OBSERVE PRECAUTIONS
FOR HANDLING
ELECTROSTATIC
DISCHARGE
SENSITIVE
DEVICES



Features

- Highest flux per LED family in the world
- Very long operating life (up to 100k hours)
- Available in White:2500K-25000K
- Lambertian radiation pattern
- More energy efficient than incandescent and most halogen lamps
- Low voltage DC operated
- Cool beam, safe to the touch
- Fully dimmable
- No UV
- Superior ESD protection
- lower R_{th}
- RoHS compliant—lead-free
- Instant light (less than 100ns)

Applications

- Portable (flashlight, bicycle)
- Reading lights(car, bus, aircraft)
- Orientation
- Mini-accent
- Decorative
- Fiber optic alternative
- Appliance
- Sign and channel letter
- Architectural detail
- Cove lighting
- Automotive exterior (Stop-Tail-turn, CHMSL, Mirror side repeat)
- Edge-lit signs(Exit, point of sale)

Radiation Pattern

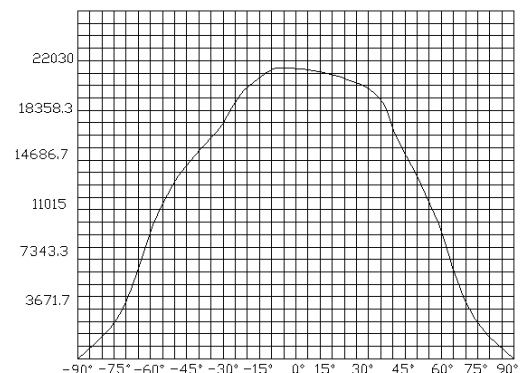
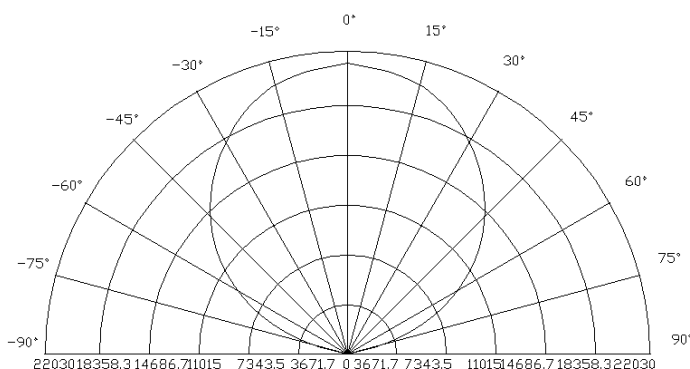

High Power Emitter LED

P/N: EWJ85EAC-LVR8 (White)

Typical Optical/ Electrical Characteristics @T_J=25°C

Item	Symbol	Condition	Min.	Typ.	Max.	Unit
Forward Voltage	V _F	IF=1.2A	3.2	--	4.0	V
Reverse Current	I _R	VR=5v	--	--	50	uA
50% Power Angle	2θ1/2	IF=1.2A	110	--	140	deg
Luminous Intensity	φ _v	IF=1.2A	147.7	169.9	--	lm
Recommend Forward Current	I _F	--	--	1.2	--	A
Chromaticity	T _c	IF=1.2A	5000	--	10000	k
Thermal Resistance,Junction to Case	R _{JP}	IF=1.2A	--	10	--	°C/w

The sample delivers goods data

Item	Symbol	Condition	Min.	Avg.	Max.	Unit
Luminous Intensity	φ _v	IF=1.2A	201	--	208	lm
50% Power Angle	2θ1/2		--	--	--	deg
Forward Voltage	V _F		3.4	3.6	3.8	v
Chromaticity	T _c		6500	6650	6800	k
White Color Region	--					
ChromaticityCoordinates	X=--			Y=--		

Notes:

- 1.Tolerance of measurement of forward voltage±0.1V.
- 2.Tolerance of measurement of peak Wavelength±2.0nm.

Absolute Maximum Rating

Item	Symbol	Absolute Maximum Rating	Unit
Forward Current	I _F	1.2	A
Peak Forward Current*	I _{FP}	1.3	A
Reverse Voltage	V _R	5	V
Power Dissipation	P _D	5	W
Electrostatic discharge	E _{SD}	±2000	V
Operation Temperature	T _{OPR}	-40~+80	°C
Storage Temperature	T _{STG}	-40~+100	°C
Lead Soldering Temperature*	T _{SOL}	Max. 260°C for 3sec Max.	

*IFP Conditions: Pulse Width≤10msec duty≤1/10

* Our MCPCB is usual use for installation and connection during application, but the ability of heat dissipation is not enough. If lighted, our high power stars will need better another type heat dissipation equipment. So we recommend the working time is not over 5-10 seconds without any heat dissipation equipment.

*Re-flow,wave peak and soak-stannum soldering etc.is not suitable for this products.

*Suggest to solder it by professional high power LED soldering machine.

High Power Emitter LED

P/N: EWJ85EAC-LVR8 (White)

Typical Optical/Electrical Characteristics Curves ($T_J=25^{\circ}\text{C}$ Unless Otherwise Noted)

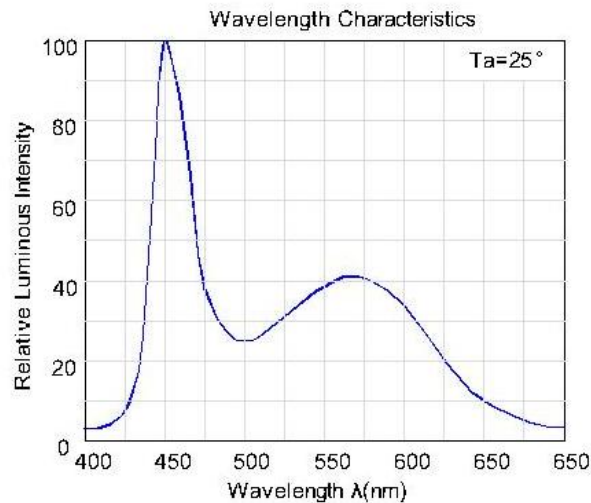
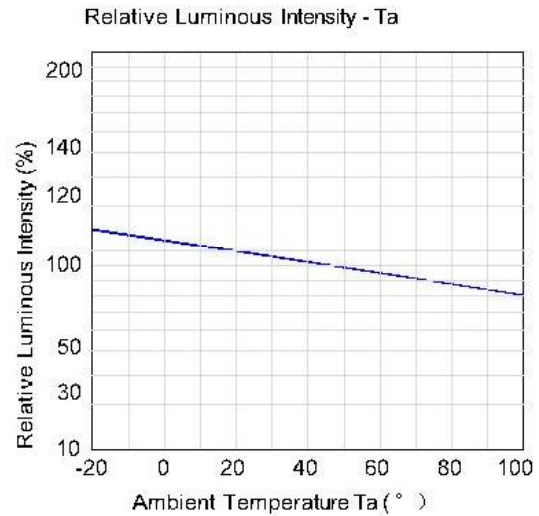
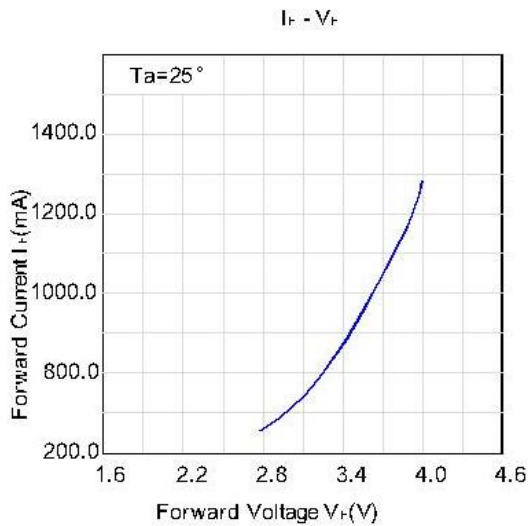
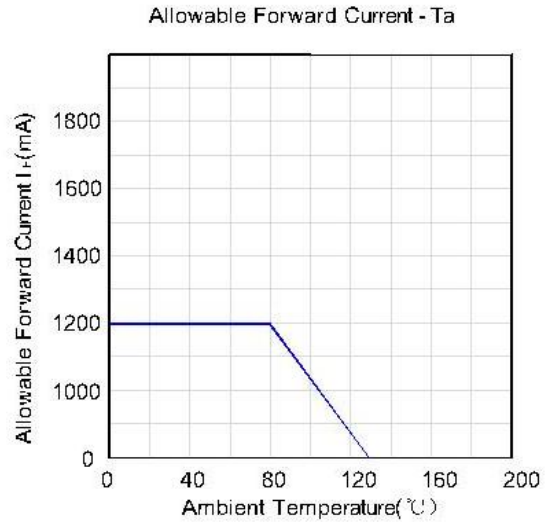
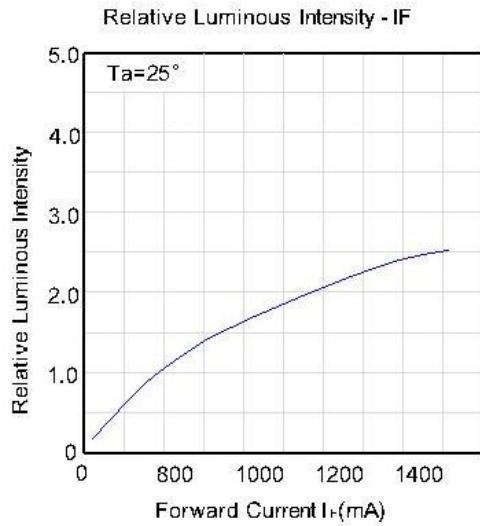

High Power Emitter LED

P/N: EWJ85EAC-LVR8 (White)

Package Dimensions

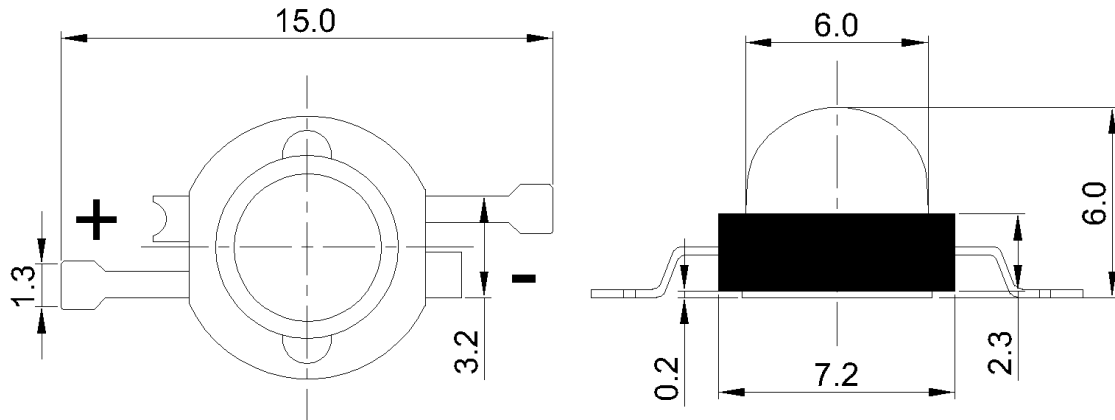

Notes:

1. All dimension units are millimeters.
2. All dimension tolerance is $\pm 0.2\text{mm}$ unless otherwise noted.

Tape Specifications(Units:mm)

