

## High Power Emitter LED

### P/N: EF5W1EAF (Warm White)



**ATTENTION**  
OBSERVE PRECAUTIONS  
FOR HANDLING  
ELECTROSTATIC  
DISCHARGE  
SENSITIVE  
DEVICES



### Features

- Long operating life
- Highest flux
- Available in White:2500K-25000K
- Lambertian radiation pattern
- More energy efficient than incandescent and most halogen lamps
- Low voltage DC operated
- Cool beam, safe to the touch
- Instant light (less than 100ns )
- Fully dimmable
- No UV
- Superior ESD protection
- Eutectic die bonding
- RoHS compliant

### Applications

- Reading lights (car, bus, aircraft)
- LCD Backlights/light Guides
- Fiber optic alternative/ Decorative / Entertainment
- Mini-accent/Up lighters/Down lighters/ Orientation
- Indoor/Outdoor commercial and Residential Architectural
- Cove/Under shelf/Task
- Bollards/Security/Garden
- Portable (flashlight, bicycle)
- Edge-lit signs (Exit, point of sale)
- Automotive Exit (Stop-Tail-Turn,CHMSL, Mirror Side Repeat)
- Traffic signaling / Beacons / RailCrossing and Wayside

### Radiation Pattern

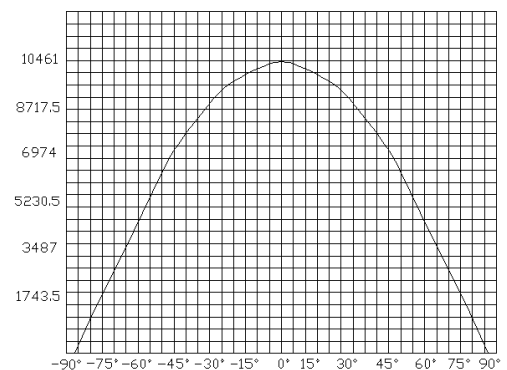
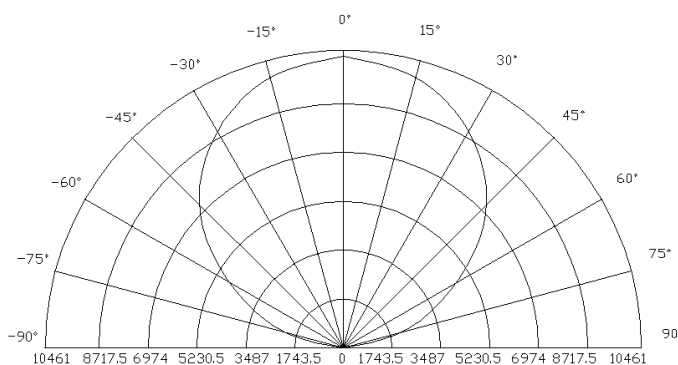

## High Power Emitter LED

### P/N: EF5W1EAF (Warm White)

#### Typical Optical/ Electrical Characteristics @T<sub>J</sub>=25°C

Item	Symbol	Condition	Min.	Typ.	Max.	Unit
Forward Voltage	V <sub>F</sub>	IF=350mA	3.0	--	3.8	V
Reverse Current	I <sub>R</sub>	VR=5v	--	--	50	uA
50% Power Angle	2θ1/2	IF=350mA	110	--	140	deg
Luminous Intensity	φ <sub>v</sub>	IF=350mA	67.2		--	lm
Recommend Forward Current	I <sub>F</sub>	--	--	350	--	mA
Chromaticity	T <sub>C</sub>	IF=350mA	2800	--	3500	k
Thermal Resistance,Junction to Case	R <sub>JP</sub>	IF=350mA	--	10	--	°C/w

The sample delivers goods data

Item	Symbol	Condition	Min.	Avg.	Max.	Unit
Luminous Intensity	φ <sub>v</sub>	IF=350mA				lm
50% Power Angle	2θ1/2					deg
Forward Voltage	V <sub>F</sub>					v
Chromaticity	T <sub>C</sub>					k
White Color Region	--					
ChromaticityCoordinates	X=--			Y=--		

#### Notes:

- 1.Tolerance of measurement of forward voltage±0.1V.
- 2.Tolerance of measurement of peak Wavelength±2.0nm.
- 3.Tolerance of measurement of luminous intensity±15%.

#### Absolute Maximum Rating

Item	Symbol	Absolute Maximum Rating	Unit
Forward Current	I <sub>F</sub>	350	mA
Peak Forward Current*	I <sub>FP</sub>	500	mA
Reverse Voltage	V <sub>R</sub>	5	V
Power Dissipation	P <sub>D</sub>	1000	mW
Electrostatic discharge	E <sub>SD</sub>	±2000	V
Operation Temperature	T <sub>OPR</sub>	-40~+80	°C
Storage Temperature	T <sub>STG</sub>	-40~+100	°C
Lead Soldering Temperature*	T <sub>SOL</sub>	Max. 260°C for 3sec Max.	

\*IFP Conditions: Pulse Width≤10msec duty≤1/10

\* All high power emitter LED products mounted on aluminum metal-core printed circuit board, can be lighted directly, but we do not recommend lighting the high power products for more than 5 seconds without a appropriate heat dissipation equipment.

\* Re-flow,wave peak and soak-stannum soldering etc.is not suitable for this products.

\* Suggest to solder it by professional high power LED soldering machine.

\* Can use invariable-temperature searing-iron with soldering condition:≤260 degree less than 3 seconds.

## High Power Emitter LED

### P/N: EF5W1EAF (Warm White)

### Typical Optical/Electrical Characteristics Curves ( $T_J=25^\circ\text{C}$ Unless Otherwise Noted)

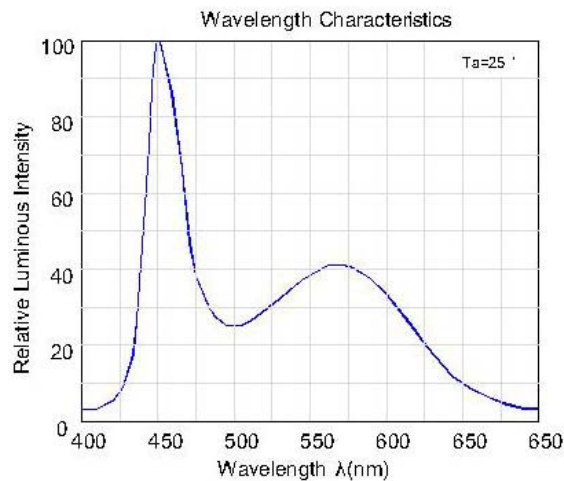
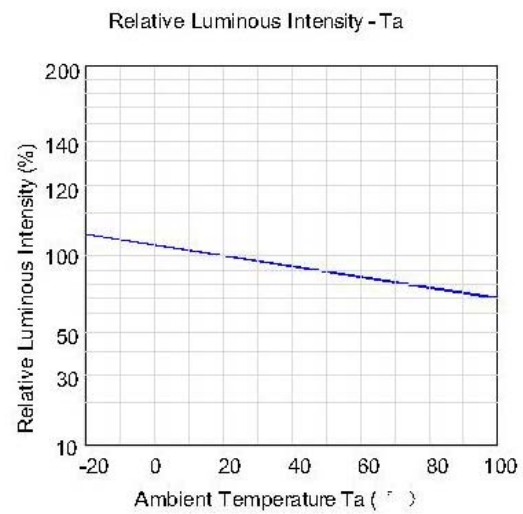
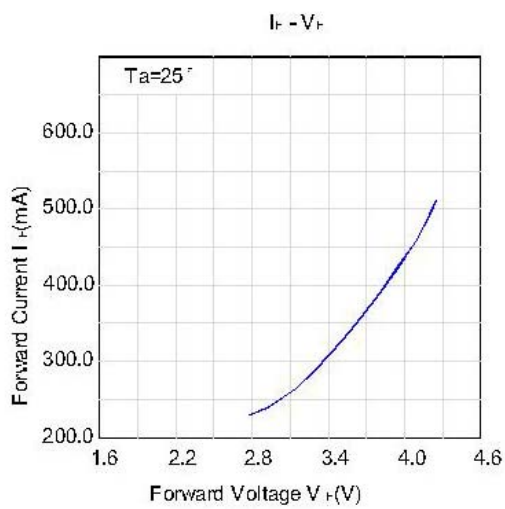
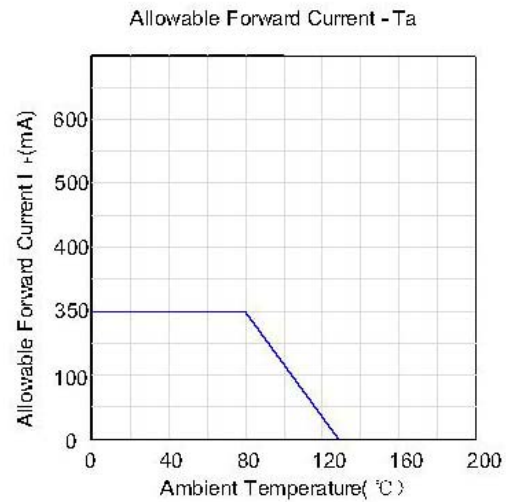
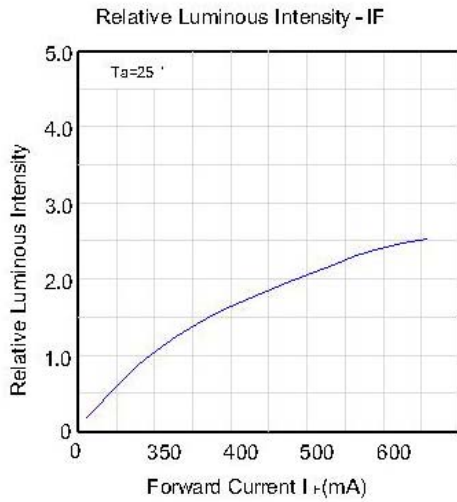

**High Power Emitter LED**  
**P/N: EF5W1EAF (Warm White)**

**Package Dimensions**

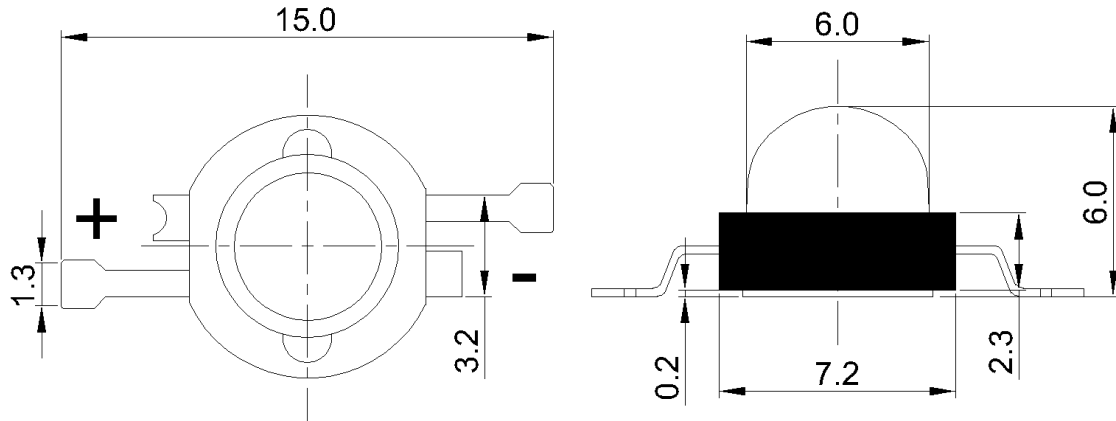

**Notes:**

1. All dimension units are millimeters.
2. All dimension tolerance is  $\pm 0.2\text{mm}$  unless otherwise noted.

**Tape Specifications(Units:mm)**

