

# HOA1887

## Transmissive Sensor

### FEATURES

- Choice of phototransistor or photodarlington output
- Side mount package
- Ambient light and dust protective filter
- Accurate position sensing
- 0.010 in.(0.25mm) aperture windows
- 0.125 in.(3.18 mm) slot width
- 24.0 in.(610 mm) min. 26 AWG UL 1429 wire leads

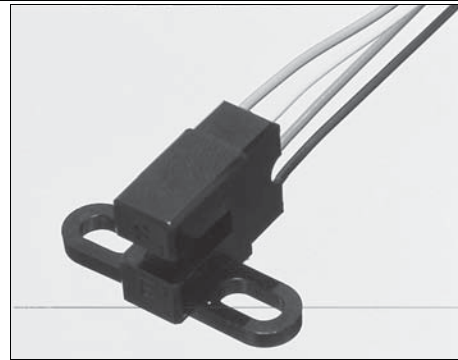

INFRA-89.TIF

### DESCRIPTION

The HOA1887 series consists of an infrared emitting diode facing an NPN silicon phototransistor (HOA1887-011, -012) or photodarlington (HOA1887-013) encased in a black thermoplastic housing. Detector switching takes place whenever an opaque object passes through the slot between emitter and detector. The side mounting package is useful in applications in which the interruptive element is parallel to the mounting plane. Both emitter and detector have a 0.010 in.(0.25 mm) x 0.60 in(1.52 mm) vertical aperture. This feature is ideal for use in applications in which maximum position resolution is desired.

All devices employ a built-in strain relief for maximum wire attachment strength. The sensor housing contains IR transmissive optical windows. This arrangement provides excellent protection against ambient light while eliminating aperture openings which could be clogged by airborne contaminants. The HOA1887 series contains plastic molded components. For additional component information see SEP8506, SDP8406, and SDP8106.

Housing material is polycarbonate. Housings are soluble in chlorinated hydrocarbons and ketones. Recommended cleaning agents are methanol and isopropanol.

Wire color and functions are:

- Red - IRED Anode
- Black - IRED Cathode
- White - Detector Collector

### OUTLINE DIMENSIONS in inches (mm)

Tolerance 3 plc decimals ±0.010(0.25)  
2 plc decimals ±0.020(0.51)

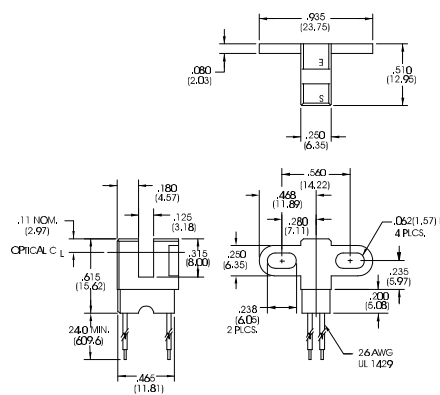

dim\_107.CDR

# HOA1887

## Transmissive Sensor

### ELECTRICAL CHARACTERISTICS (25°C unless otherwise noted)

PARAMETER	SYMBOL	MIN	TYP	MAX	UNITS	TEST CONDITIONS
<b>IR EMITTER</b>						
Forward Voltage	$V_F$			1.6	V	$I_F=20$ mA
Reverse Leakage Current	$I_R$			10	$\mu$ A	$V_R=3$ V
<b>DETECTOR</b>						
Collector-Emitter Breakdown Voltage	$V_{(BR)CEO}$				V	$I_C=100$ $\mu$ A
HOA1887-011, -012		30				
HOA1887-013		15				
Emitter-Collector Breakdown Voltage	$V_{(BR)ECO}$	5.0			V	$I_E=100$ $\mu$ A
Collector Dark Current	$I_{CEO}$				nA	$V_{CE}=10$ V $I_F=0$
HOA1887-011, -012				100		
HOA1887-013				250		
<b>COUPLED CHARACTERISTICS</b>						
On-State Collector Current	$I_{C(ON)}$				mA	$V_{CE}=5$ V $I_F=20$ mA
HOA1887-011		0.3				
HOA1887-012		1.8				
HOA1887-013		4.0				
Collector-Emitter Saturation Voltage	$V_{CE(SAT)}$				V	$I_F=20$ mA $I_C=40$ $\mu$ A $I_C=230$ $\mu$ A $I_C=500$ $\mu$ A
HOA1887-011				0.4		
HOA1887-012				0.4		
HOA1887-013				1.1		
Rise And Fall Time	$t_r, t_f$				$\mu$ s	$V_{CC}=5$ V, $I_C=1$ mA $R_L=1000$ $\Omega$ $R_L=100$ $\Omega$
HOA1887-011, -012			15			
HOA1887-013			75			

### ABSOLUTE MAXIMUM RATINGS

(25°C Free-Air Temperature unless otherwise noted)

Operating Temperature Range -40°C to 85°C

Storage Temperature Range -40°C to 85°C

Soldering Temperature (5 sec) 240°C

#### IR EMITTER

Power Dissipation 100 mW <sup>(1)</sup>

Reverse Voltage 3 V

Continuous Forward Current 50 mA

#### DETECTOR

Collector-Emitter Voltage **TRANS. DARLINGTON**  
30 V 15 V

Emitter-Collector Voltage 5 V 5 V

Power Dissipation 100 mW <sup>(1)</sup> 100 mW <sup>(1)</sup>

Collector DC Current 30 mA 30 mA

### SCHEMATIC

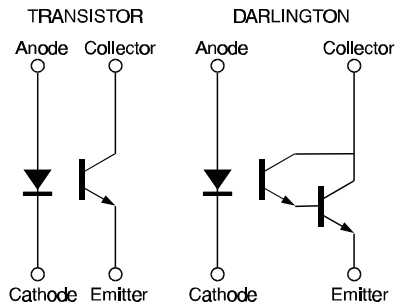

Honeywell reserves the right to make changes in order to improve design and supply the best products possible.

# Honeywell

339

# HOA1887

## Transmissive Sensor

Fig. 1 IRED Forward Bias Characteristics

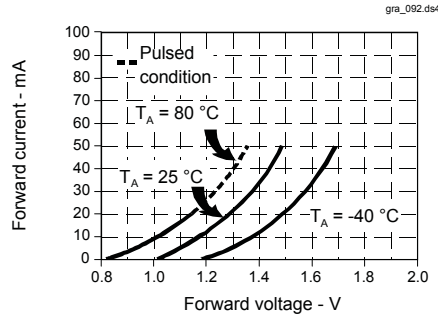

Fig. 2 Non-Saturated Switching Time vs Load Resistance

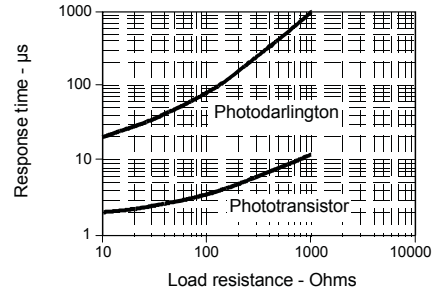

Fig. 3 Detector Dark Current vs Temperature

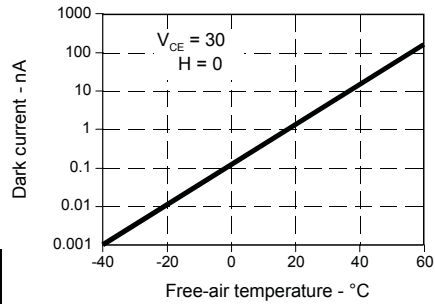
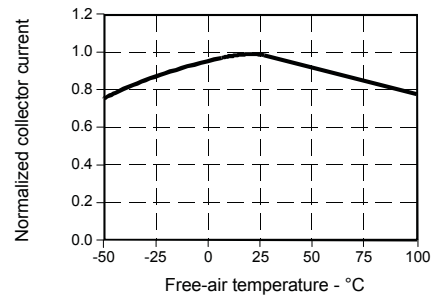

Fig. 4 Collector Current vs Ambient Temperature



All Performance Curves Show Typical Values

**HOA1887**

Transmissive Sensor

---



Honeywell reserves the right to make changes in order to improve design and supply the best products possible.

**Honeywell**